

COMBIMASTER 411 & MICROMASTER 411

Getting Started Guide



This Getting Started Guide allows for easy and efficient commissioning of the Siemens COMBIMASTER 411 and MICROMASTER 411 Inverters. For further technical information, please refer to the **Operating Instructions** and the **Parameter List** on the CD-ROM supplied with COMBIMASTER 411 and MICROMASTER 411.

Contents

1	Installation	3
1.1	Installation to Motor	3
1.2	Electrical Installation	6
2	Avoiding Electro-Magnetic Interference	8
3	Commissioning COMBIMASTER 411/MICROMASTER 411.	8
3.1	General Information	8
3.2	Commissioning Procedure Overview	9
4	Quick Commissioning	14
4.1	Commissioning with BOP	14
4.1	Reset to Factory Defaults	15
4.2	Additional Control Applications	15
4.2	Further information	15
5	Dimensions	15
5.1	MICROMASTER 411 - Dimensions.	15
5.2	COMBIMASTER 411 - Dimensions.	16



Warnings

- This equipment contains dangerous voltages and controls potentially dangerous rotating mechanical parts. Non-compliance with **Warnings** or failure to follow the instructions contained in this manual can result in loss of life, severe personal injury or serious damage to property.
- Only suitably qualified personnel should work on this equipment, and only after becoming familiar with all safety notices, installation, operation and maintenance procedures contained in this manual. The successful and safe operation of this equipment is dependent upon its proper handling, installation, operation and maintenance.
- The DC link of all MICROMASTER modules remains at a hazardous voltage level for 5 minutes after all voltages have been disconnected. Therefore always wait for 5 minutes after disconnecting the inverter from the power supply before carrying out work on any MICROMASTER modules.
- This equipment is capable of providing internal motor overload protection. Refer to P0610 (level 3) and P0335, I2T is ON by default. Motor overload protection can also be provided using an external PTC via a digital input.
- This equipment is suitable for use in a circuit capable of delivering not more than 10,000 symmetrical amperes (rms), for a maximum voltage of 460V when protected by an H or K Class fuse. (For further information refer to Operating Instructions).
- Class 1 75 °C copper wire only.
- See Operating Instructions for recommended tightening torques.
- If a Residual Current-operated protective Device (RCD) is to be used, it **must** be an RCD Type B.
- COMBIMASTER 411 & MICROMASTER 411 **cannot** be used on unearthed power supplies (IT).



Caution

- Children and the general public must be prevented from accessing or approaching the equipment!
- This equipment may only be used for the purpose specified by the manufacturer. Unauthorized modifications and the use of spare parts and accessories that are not sold or recommended by the manufacturer of the equipment can cause fires, electric shocks and injuries.

Notes

- Keep this Getting Started Guide within easy reach of the equipment. Ensure that it is available to all users.
- Whenever measuring or testing has to be performed on live equipment regulations of Safety Code VBG 4.0 must be observed, in particular § 8 'Permissible Deviations when Working on Live Parts'. Suitable electronic tools should be used.
- Before carrying out any Installation and Commissioning procedures, you **must** read all safety instructions and warnings, including all warning labels attached to the equipment. Make sure that the warning labels are kept in a legible condition and ensure missing or damaged labels are replaced.
- All measurements are in metric. To convert to inches use a conversion factor of 0.039.
- Power values are given in kW. To convert from kW into hp use a conversion factor of 1.34.



= Ground/Protective Earth

1 Installation



WARNING

- **THIS EQUIPMENT MUST BE GROUNDED.**
- To ensure safe operation of the inverter, it must be installed and commissioned by qualified personnel in full compliance with the warnings laid down in the COMBIMASTER 411 and MICROMASTER 411 operating instructions.
- Take particular note of general and regional installation, and safety regulations regarding work on dangerous voltage installations (e.g. EN 50178), as well as the relevant regulations regarding correct use of tools and personal protective gear.
- Use Lifting Eyes provided if a motor has to be lifted. Do not lift machine sets by suspending individual machines! Always check Hoist capacity before lifting any equipment.
- Do not paint over the black case finish of the inverter, as this will affect the unit's thermal performance.

1.1 Installation to Motor

1.1.1 Preparation

The Installation Kit should comprise the following items:

- | | |
|--|---|
| 1. Inverter cover | 9. 2 off M25 sealing plugs |
| 2. Terminal Housing | 10. 2 off M25 Gland Fixing Plates |
| 3. Filter Module & screws (captive) | 11. 2 off U-clamp & screws (for earth/ground connection) |
| 4. Input – Output Board & screws (captive) | 12. 4 off M4 Inverter to Motor fixing screws (CSC only: additional 4 off M5 screws) |
| 5. Earth Lead | 13. Motor Cable Sheath |
| 6. 10 Off Terminal Jumpers | 14. 1 off Motor Gasket (CSC only: additional 1 off Motor Gasket) |
| 7. Getting Started Guide and CD | 15. 1 off M12 connector blanking plug |
| 8. 2 off Glands M25 IP68 with O-ring | |

Any defective or missing items should be reported immediately to your local Siemens Distributor or Sales Office.

1.1.2 Installation Procedure

Note

MICROMASTER 411 ONLY:

Prior to installation it may be necessary to fit an Adaptation Plate to a non-Siemens motor. The Adaptation Plate is prepared by the respective motor manufacturer. Normally the Adaptation Plate makes use of the existing motor gasket.

Physical dimensions and characteristics for installation of MICROMASTER 411 are given in Section 2.3.7 and in Section 2.4.2 for COMBIMASTER 411 of the Operating Instructions.

With the product items removed from their packaging carry out the following installation procedure (refer to Figure 3 for location of components):

1. Separate the two halves (Inverter Cover and Terminal Housing).
2. Remove the Filter Module and I/O board.



Caution

Do not knock out cable gland blanking plates unless the inverter 'electronics' (Filter & I/O boards) have been removed!

3. Remove the cable gland blanking plates (knockouts) as required. See Figures 1 and 2.
4. Fit cable glands to terminal housing, ensuring the O-rings are fitted to ensure the seal is maintained.
5. Fit the earth lead to the earth terminal within the motor terminal box. If required fit a Motor PTC cable (not supplied).
6. Run all cables between the motor and inverter within the cable sheath provided.
7. Using the appropriate motor gasket, fix the terminal housing to the motor. Screw fixing torque values are: 1.5 Nm – M4 and 2.5 Nm – M5.
8. Insert power and control cables through glands and make off ends as required.
9. Fit the Filter Board (See Figure 3).
10. Secure Filter board with M3 taptite screws (0.8 Nm).
11. Connect power cables as detailed in Section 1.2.1.
12. Connect up the motor terminals in either star or delta configuration as described in Section 1.2.2.
13. Connect control wires as described in Section 1.2.3.
14. Fit the I/O board (see Figure 3).
15. Secure I/O board with M3 taptite screws (0.8 Nm).
16. Fit jumpers as required (see Section 3.2.1).
17. Place the inverter cover onto the assembled terminal housing.
18. Secure the inverter cover with the four M5 captive screws.
Use either a 4-5 mm flat bladed screwdriver or a 2pt Pozidrive Head screwdriver.

1.1.3 Installation of Cable Glands

Before power and control cables can be connected to their respective circuits it will first be necessary to fit the cable glands supplied.

Each gland should preferably be located to allow for convenient cable runs to the terminals located on the Filter and I/O boards.

Figure 1

Using a hammer as shown opposite strike the gland plate or 'knockout' to obtain a clearance for the 25 mm cable gland.

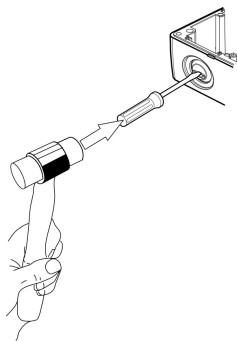

Remove any sharp edges from the gland area and any swarf from the terminal housing.

Figure 2

After the knockout has been removed it should be safely discarded and the cable glands fitted as shown in the assembly diagram opposite.

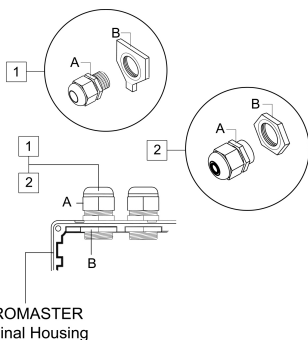

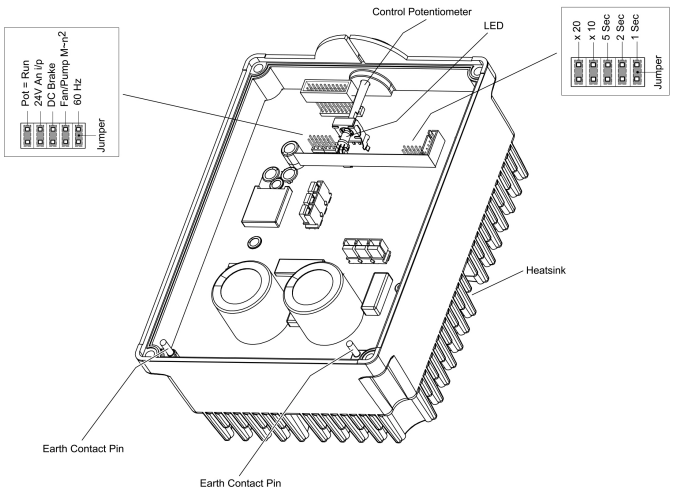

Inverter Cover (CSB)

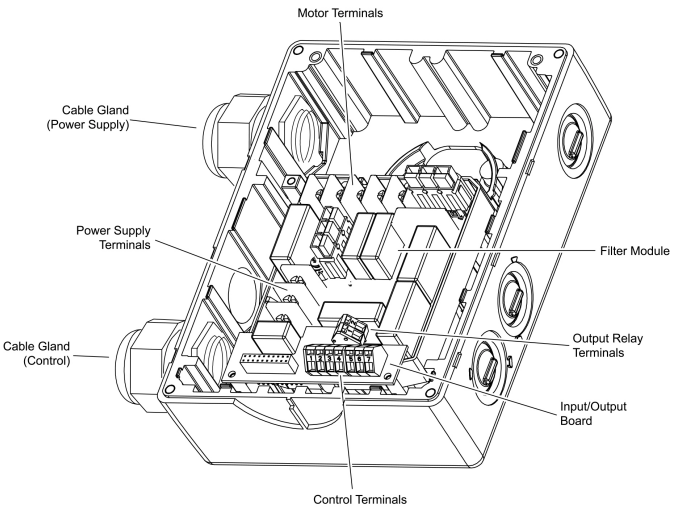

Terminal Housing (CSB) (Cable glands shown in preferred positions)

Figure 3 Internal Layout

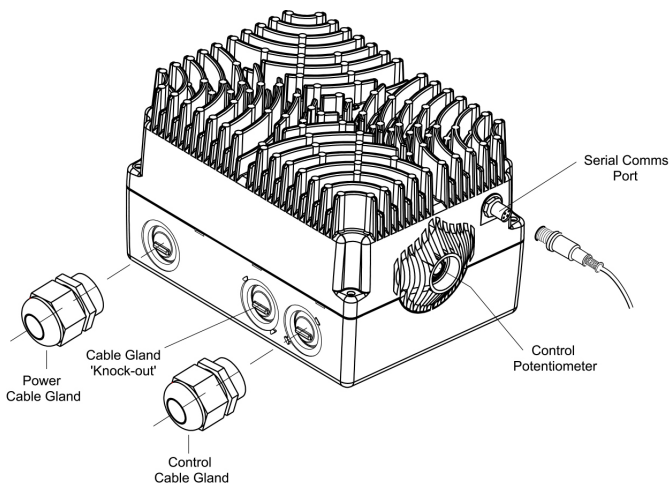

Figure 4 MICROMASTER 411 General Layout

1.2 Electrical Installation

1.2.1 Power Cable Connections

1. If the Inverter cover (the top-half) has already been fitted unscrew the four M5 cross-head captive screws on the inverter cover.
2. Remove inverter (cover) to access electrical terminals.
3. Feed the power cable into the terminal housing via the appropriate gland hole.
4. Connect power leads to terminals L1, L2, L3 and to the separate earth.

To avoid snagging on components when the inverter halves are brought together run cables along the base of the terminal housing.

5. Use Class 1 75° C copper wire only. Use a 4-core cable. If crimp terminals are used they must be insulated. If crimps are not used, the strip length must not exceed 5 mm. Use a 4 - 5 mm cross-tip screwdriver to tighten the terminal screws.
6. Recommended tightening torque for power supply terminals is as given below.

Power Terminals	Units of measurement	CSB	CSC
Power Supply Terminal Tightening Torque	[Nm]	1.3	1.3
	[lbf.in]	12	12
Minimum Cable Cross Section	[mm ²]	1.5	2.5
	[AWG]	16	14
Maximum Cable Cross Section	[mm ²]	4	4
	[AWG]	12	12

7. A 'drip loop' is recommended when connecting the mains and control cables.
8. Ensure that the power source provides the correct voltage and is designed for the rated current. Use appropriate circuit breakers with specified current rating between the power supply and inverter.
9. Ensure the appropriate circuit breakers/fuses with the specified current rating are connected between the power supply and the inverter. See Section 7.5 of the Operating Instructions for further details.



Warning

- It is essential that the Inverter be correctly grounded to the motor ground. Severe injury may result if the motor is not correctly grounded.
- If the inverter is being installed after a period of storage please refer to Section 2.1 of the Operating Instructions.

1.2.2 Motor Connections for Star/Delta

The following information shows the connection of the motor wires to inverter/motor terminals. Motor wires should be connected in either star or delta configuration, in accordance with the motor rating plate.

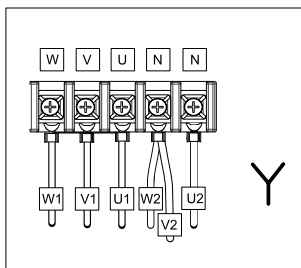

Star connection

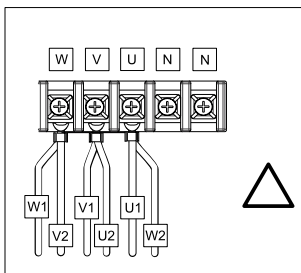

Delta connection

Figure 5 Star/Delta Connections

1.2.3 Control Cable Connections



Caution

- It is essential that control and power supply cables be run separately. They must not be fed through the same cable conduit/trunking.

1. Feed the control cable into the inverter via one of the gland holes at the I/O module end of the terminal housing.
2. Run the control cable underneath the I/O board toward the control terminals.
3. Connect the control wires in accordance with the terminal information given in Figure 6.
4. Use screened cable for all control wiring. Cable connections for Control Terminals are as given in Figure 6.

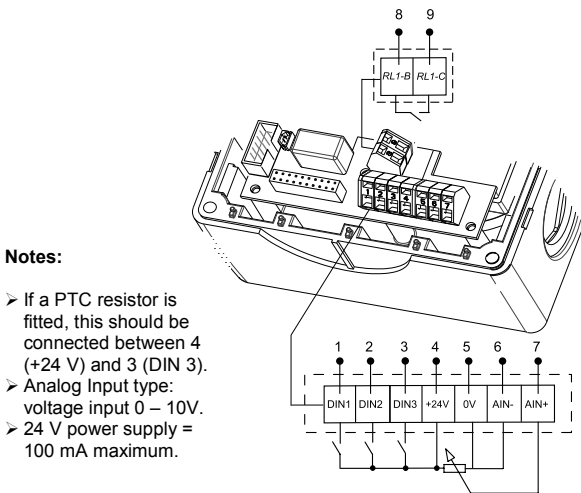

Notes:

- If a PTC resistor is fitted, this should be connected between 4 (+24 V) and 3 (DIN 3).
- Analog Input type: voltage input 0 – 10V.
- 24 V power supply = 100 mA maximum.

Figure 6 Control Circuit Input Terminals

Terminal	Inputs	Default operation
1	Digital Input 1 [DIN1]	ON/OFF1
2	Digital Input 2 [DIN2]	Reverse
3	Digital Input 3 [DIN3]	Fault Acknowledge
6/7	Analog Input (-/+) [AIN]	0 – 10 V Analogue Input
	Option: DIN4	
8/9	Output Relay	Fault identification

2 Avoiding Electro-Magnetic Interference

Good installation practices will ensure safe and trouble-free operation. For further information see Operating Instructions.

3 Commissioning COMBIMASTER 411/MICROMASTER 411.

3.1 General Information

For default operation no additional equipment is required. However, for more complex operation either the Basic Operator Panel (BOP), Advanced Operator Panel (AOP) or Fieldbus options can be used. These are available as non-standard options and must be ordered separately.

When delivered the inverter has a frequency setpoint range of between 0 Hz and 50 Hz. Regardless of its initial position the Control Potentiometer must be turned fully counter-clockwise before the inverter can start.



Warning

The inverter does not have a mains power switch and is therefore live when the power supply is connected.

3.2 Commissioning Procedure Overview

COMBIMASTER 411 and MICROMASTER 411 can be commissioned in a variety of ways as explained in sections 3.2.1. to 3.2.6 below.

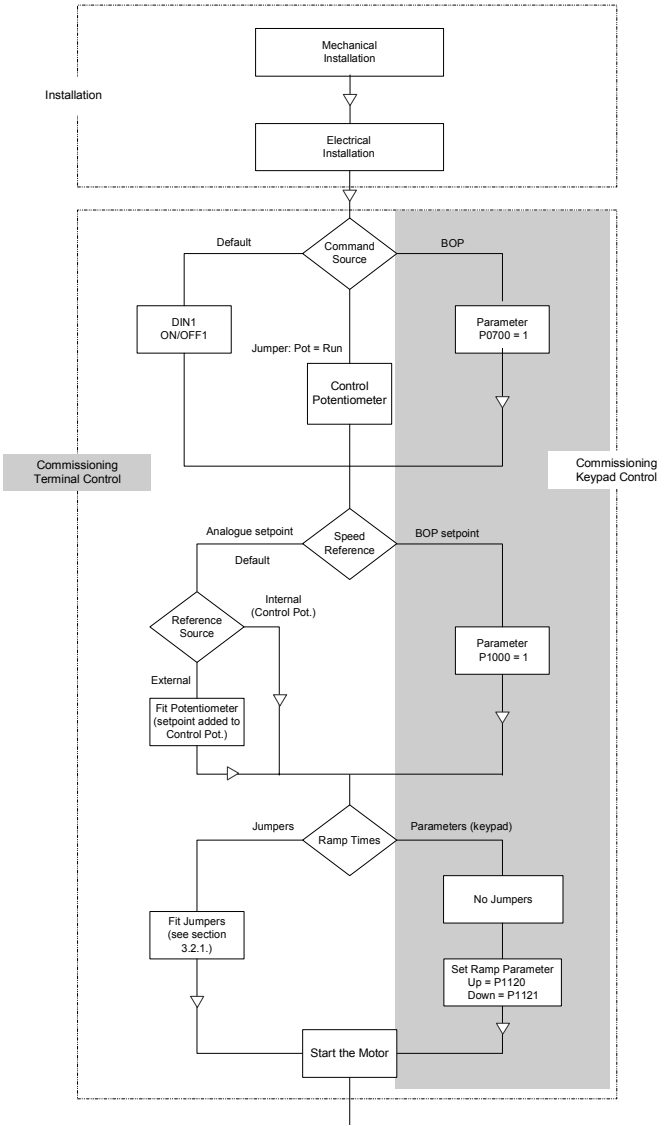

3.2.1 Ramp Times Using Jumpers

Inverter ramp times can be set using a series of 5 jumpers (fit the jumpers to enable the function). These are as shown below:

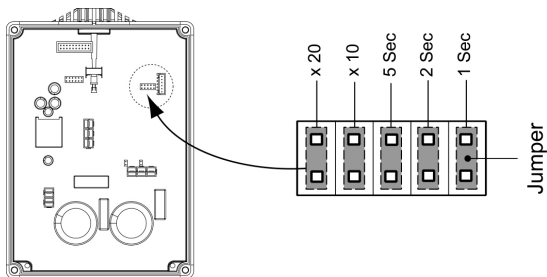

Using up to 5 jumpers allows ramp times to be set between 1 to 240 secs. See table below for details of settings:

Time	1sec	2sec	5sec	X10	X20
1s	✓				
2s		✓			
3s	✓	✓			
5s			✓		
6s	✓		✓		
7s		✓	✓		
8s	✓	✓	✓		
10s	✓			✓	
20s		✓		✓	
30s	✓	✓		✓	
50s			✓	✓	
60s	✓		✓	✓	
70s		✓	✓	✓	
80s	✓	✓	✓	✓	
90s	✓	✓		✓	✓
100s			✓		✓
120s	✓		✓		✓
140s		✓	✓		✓
150s			✓	✓	✓
160s	✓	✓	✓		✓
180s	✓		✓	✓	✓
210s		✓	✓	✓	✓
240s	✓	✓	✓	✓	✓

Ramp Time Jumpers

In the following table the behaviour of the Jumpers for ramp times are explained:

Status before action(s)	Action(s)	Reaction(s) of the inverter
<ul style="list-style-type: none"> No jumper fitted Ramp times have arbitrary setting 	<ul style="list-style-type: none"> Power down Fit jumper(s) Power up 	<ul style="list-style-type: none"> Inverter uses the ramp times defined by the current jumper setting
<ul style="list-style-type: none"> At least 1 jumper is fitted Ramp times have arbitrary setting 	<ul style="list-style-type: none"> Cycle power 	<ul style="list-style-type: none"> Inverter uses the ramp times defined by the current jumper setting
<ul style="list-style-type: none"> At least 1 jumper is fitted Ramp times have arbitrary setting 	<ul style="list-style-type: none"> Power down Remove jumper(s) Power up 	<ul style="list-style-type: none"> Inverter uses the ramp times that were used before removing the jumper(s)

3.2.2 Control Circuit Jumpers

Control Jumpers are provided for the following functions (fit the jumpers to enable the function). Jumpers can only be accessed when the cover is removed:

1. Pot = Run: Enables the control potentiometer as the Command Source (auto restart is enabled).
2. 24 V Analog input: to change analog input range from 0-10V to 0-24V.
3. DC Brake: to change Stop function from OFF1 to DC Brake.
4. Fan/Pump: $M \sim n^2$: to change V/f curve from Linear to Quadratic curve.
5. 60Hz operation: to change motor default settings from 50Hz to 60 Hz.

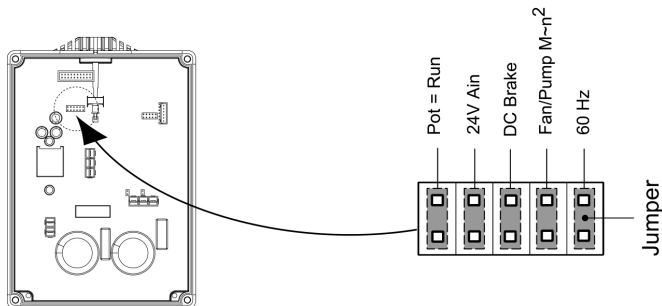

Warning

With the DC Brake Jumper set, when stopping the inverter, DC Braking is applied for a period proportional to the Ramp Down Time.

Frequent use of long periods of DC injection braking can cause the motor and inverter to overheat.

Control Jumpers

In the following table the behaviour of the Control Jumpers are explained:

Status before action(s)	Action(s)	Reaction(s) of the inverter
• Jumper not fitted	• Power down • Fit jumper • Power up	• Parameters influenced by jumper will have jumper default values
• Jumper fitted	• Cycle power	• Parameters influenced by jumper are not changed
• Jumper fitted	• Power down • Remove jumper • Power up	• Parameters influenced by jumper will have "jumper removed" default (normally factory default)
• Jumper not fitted	• Cycle power	• Parameters influenced by jumper are not changed

3.2.3 Default Setup

To change parameters it is necessary to use a Basic Operator Panel (BOP), Advanced Operator Panel (AOP) or an external serial interface. The CM411 is therefore delivered with the following default settings:

- Setpoint control from the analog input in addition to Control Potentiometer.
- Supply frequency set for 0 to 50 Hz.
- Digital inputs:
DIN1 ON/OFF1
DIN2 Reverse
DIN3 Fault Acknowledge.
- Jumpers for Ramp and Control circuits set to open. Refer to previous section for details of jumper settings.
- Relay – Fault conditions.

3.2.4 Default Operation

For default operation, connect the control terminals as shown in Figure 6. The default settings of the terminals are described in the table below Figure 6.

- FREQUENCY SETPOINT: - Setpoint addition: Control Potentiometer and Analog Input (P1000 = 27).

In order to provide the unit with a Frequency Setpoint the user can either:

1. Turn the Control Potentiometer.
2. Fit an external potentiometer, or apply an external analog control voltage across terminals 6 and 7.

Note

When using the analog input only, the control potentiometer should be turned fully anti-clockwise to ensure that the control potentiometer is de-activated.

3.2.5 Operation using "Pot = Run" Jumper

With the "Pot = Run" jumper fitted, the control potentiometer provides the ON/OFF command source.

In order to provide the unit with a Run command the Control Potentiometer must be turned in a clockwise direction. To switch the unit OFF, turn the Control Potentiometer fully anti-clockwise (OFF position).

Warning



If the unit is powered up when the Control Potentiometer is not in the OFF position, the unit may automatically restart and ramp-up to the frequency setpoint (Auto-restart function is active by default).

3.2.6 Non - Default Modes of Operation

Non-default modes of operation require the use of either a Keypad (e.g., Basic Operator Panel or Advanced Operator Panel) or a Commissioning tool (e.g., Drive Monitor) in order to change from the default parameter settings.

The Basic Operator Panel (BOP) – Part Number: 6SE6400-0BP00-0AA0 is housed in an Operator Panel Mounting Kit (6SE6401-1DF00-0AA0) and connected via the Interface Link Cable to the Inverter serial comms port. This arrangement is shown in the diagram below.

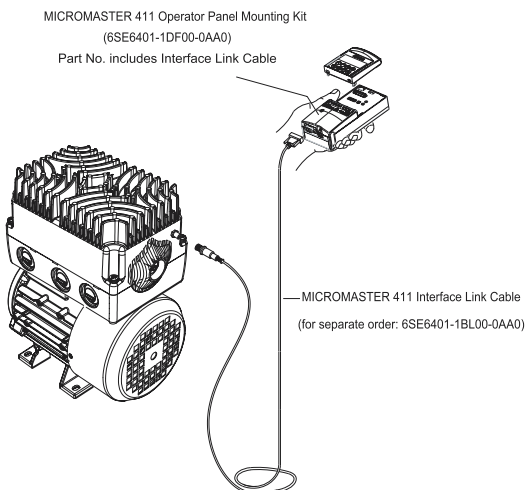

3.2.7 Fault Diagnostics

Check the status of the LED located adjacent to the external potentiometer:

Condition	Status
200 ms on/800 ms off	Power On/Ready
Continuous on	Running
800 ms on/200 ms off	Warning (general)
500 ms on/500 ms off	Trip (general)
Off	Off/Mains supply fault/No inverter power

If a fault occurs:

1. Switch the inverter off.
2. Disconnect the power supply.
3. Reconnect the power supply.
4. Switch on again.
5. Faults are acknowledged by using digital input DIN 3 (default setting).

Switch off the inverter if the fault condition persists.

For further fault code designations, please refer to the COMBIMASTER 411 and MICROMASTER 411 Operating Instructions on the CD included with the inverter.

4 Quick Commissioning

4.1 Commissioning with BOP

Motor parameters detailed below are already set for the respective Siemens motor at the factory. In order to change parameter settings, use either a BOP/AOP or a Commissioning Tool (e.g., Drive Monitor).

The parameter sequence below ensures optimized and efficient operation of the inverter. Note that P0010 must be set to 1 to allow this procedure to be performed.

When fitted, the jumpers override the parameter settings.

<p>P0010 Start Quick Commissioning 0 = Ready to Run 1 = Quick Commissioning 30 = Factory Setting Please note that P0010 must always be set back to '0' before operating the motor. However if P3900 = 1 is set after commissioning this is done automatically.</p>	<p>P0700 Selection of Command Source § (On / off / reverse) 1 = Basic Operator Panel 2 = Terminal/Digital Inputs (Default).</p>
<p>P0100 Operation for Europe / N. America 0 = Power in kW; <i>f</i> default 50 Hz 1 = Power in hp; <i>f</i> default 60 Hz 2 = Power in kW; <i>f</i> default 60 Hz Note: settings 0 & 1 can be changed using Jumper 60 Hz.</p>	<p>P1000 Selection of Frequency Setpoint § 0 = No frequency setpoint 1 = BOP frequency control  27 = Setpoint Addition: Analogue Setpoint & Control Potentiometer (Default).</p>
<p>P0304 *Rated Motor Voltage 10 – 2000 V Nominal motor voltage (V) from rating plate. Set in factory for respective motor</p>	<p>P1080 Min. Motor Frequency Sets minimum motor frequency (0-650Hz) at which the motor will run irrespective of the frequency setpoint. The value set here is valid for both clockwise and anti-clockwise rotation.</p>
<p>P0305 *Rated Motor Current 0 – 2 x inverter rated current (A) Nominal motor current (A) from rating plate. Set in factory for respective motor.</p>	<p>P1082 Max. Motor Frequency Sets maximum motor frequency (0-650Hz) at which the motor will run at irrespective of the frequency setpoint. The value set here is valid for both clockwise and anti-clockwise rotation.</p>
<p>P0307 *Rated Motor Power 0 – 2000 kW Nominal motor power (kW) from rating plate. If P0100 = 1, values will be in hp. Set in factory for respective motor</p>	<p>P1120 Ramp-Up Time 0 – 650 s Time taken for the motor to accelerate from standstill up to maximum motor frequency.</p>
<p>P0310 *Rated Motor Frequency 12 – 650Hz Nominal motor frequency (Hz) from rating plate. Set in factory for respective motor.</p>	<p>P1121 Ramp-Down Time 0 – 650s Time taken for motor to decelerate from maximum motor frequency down to standstill.</p>
<p>P0311 *Rated Motor Speed 0 – 40000 1/min Nominal motor speed (rpm) from rating plate. Set in factory for respective motor</p>	<p>P3900 End Quick Commissioning 0 = No Quick Commissioning without motor calculation or factory reset. 1 = Perform Quick Commissioning with factory reset of all other parameters. (Recommended)</p>

Table Footnotes

§ Denotes parameters that contain detailed lists of possible settings for use in specific applications. Refer to the Operating Instructions and Operating Instructions on the CD.

* Motor related parameters – please refer to motor rating plate drawing.

4.1 Reset to Factory Defaults

For factory default settings set P0970 to 1 (with P0010 = 30). Where the inverter is integrated with a non-Siemens motor, setting P0970 = 1 restores the default parameter settings for the respective motor.

4.2 Additional Control Applications

The COMBIMASTER 411 and MICROMASTER 411 may also be controlled by the following means:

- Digital inputs / Analogue inputs
- Serial Link via USS Protocol
- BOP/AOP Keypad Control

(Requires option module 6SE6401-1BL00-0AA0)

- Automated system via PROFIBUS connection (requires PROFIBUS module 6SE6401-1PB00 - 0AA0).

4.2 Further information

For further information please refer to the Operating Instructions and Parameter Lists on the CD delivered with the unit.

5 Dimensions

5.1 MICROMASTER 411 - Dimensions.

Case Size	Overall Dimensions mm (inches)			Weight kg (lbs)	Power Range kW (hp)
	Height	Width	Depth		
B	135.6 (5.31)	222 (8.74)	154 (6.06)	4.9 (10.77)	0.37 – 1.5 (0.5 – 2.0)
C	170.6 (6.61)	255 (10.04)	177 (6.97)	7.4 (16.34)	2.2 – 3.0 (3.0 – 4.0)

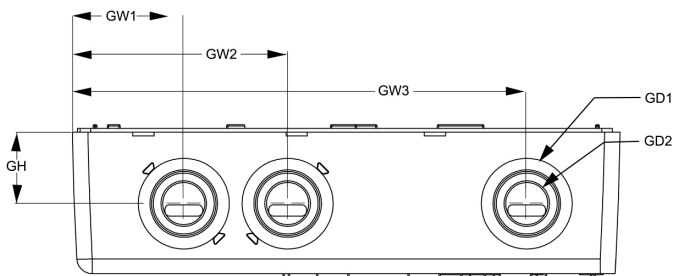

Case Size	Gland Pitch mm (inches)			Height mm (inches)	Sealing Surface mm (inches)	Knock-out Diameter mm (inches)
	GW1	GW2	GW3			
B	42.9 (1.68)	82.9 (3.26)	175.0 (6.89)	27.6 (1.09)	35 (1.38)	26 (1.02)
C	43 (1.69)	83.0 (3.27)	203.4 (8.01)	38.3 (1.51)	36 (1.42)	26 (1.02)

Figure 5 Gland Dimensions

5.2 COMBIMASTER 411 - Dimensions.

Case Size B

	MOTOR FRAME SIZE		
	71M	80M	90S
Height mm (inches)	278.6 (11.0)	296.6 (11.7)	314.6 (12.4)
Width mm (inches)	132 (5.2)	150 (5.9)	165 (6.5)
Length mm (inches)	240 (9.4)	274 (10.8)	331 (13.0)
Rating 2P kW (hp)	0.37 (0.5) 0.55 (0.75)	0.75 (1.0) 1.1 (1.5)	1.5 (2.0)
Rating 4P kW (hp)	0.37 (0.5)	0.55 (0.75) 0.75 (1.0)	1.1 (1.5) 1.5 (2.0)

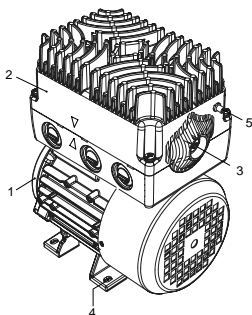

- 1-Motor Frame
- 2-CSB Inverter
- 3-Control Potentiometer
- 4-Fixing
- 5-Comms Interface

Case Size C

	MOTOR FRAME SIZE	
	90L	100L
Height mm (inches)	349.5 (13.8)	370 (14.6)
Width mm (inches)	165 (6.5)	196 (7.7)
Length mm (inches)	332 (13.1)	373 (14.7)
Rating 2P kW (hp)	2.2 (3.0)	3.0 (4.0)
Rating 4P kW (hp)	-	2.2 (3.0) 3.0 (4.0)

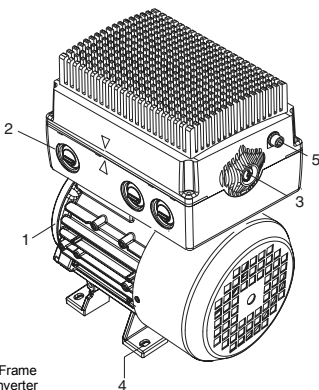

- 1-Motor Frame
- 2-CSC Inverter
- 3-Control Potentiometer
- 4-Fixing
- 5-Comms Interface

Note:

For details of motor construction (feet and flange dimensions) please refer to the Operating Instructions.

NOTES

NOTES



European Low Voltage Directive

The MICROMASTER product range complies with the requirements of the Low Voltage Directive 73/23/EEC as amended by Directive 98/68/EEC. The units are certified for compliance with the following standards:

- | | |
|--------------|--|
| EN 60146-1-1 | Semiconductor inverters - General requirements and line commutated inverters |
| EN 60204-1 | Safety of machinery - Electrical equipment of machine |

European Machinery Directive

The MICROMASTER inverter series does not fall under the scope of the Machinery Directive. However, the products have been fully evaluated for compliance with the essential Health & Safety Requirements of the directive when used in a typical machine application. A Declaration of incorporation is available on request.

European EMC Directive

When installed according to the recommendations described in this guide, the MICROMASTER fulfils all requirements of the EMC Directive as defined by the EMC Product Standard for Power Drive Systems EN61800-3.



Underwriters Laboratories

UL and CUL LISTED POWER CONVERSION EQUIPMENT 5B33 for use in a pollution degree 2

Not all inverters currently have UL Approval. UL listing can be determined by examining the inverter's rating label.

ISO 9001

Siemens plc operates a quality management system, which complies with the requirements of ISO 9001.

To submit any suggestions for improvements, please visit the Siemens Standard Drives Web Site at <http://www.siemens.de/micromaster>

Printed in England

CADIM Nr. A5E00157510A

Siemens plc
Automation & Drives
Standard Drives Division
Varey Road,
Congleton, CW12 1PH
United Kingdom